

Amika

Enteral feeding pump

Instructions for Use



MEDICAL DEVICES













**FRESENIUS
KABI**









caring for life

Description of the symbols used on the device and its packaging

Identification labels symbols

Symbol	Description	Symbol	Description
	Refer to the Instructions For Use	IP34	Index of protection against solid foreign objects (> 2.5 mm) and splashing liquids
	Protection against leakage current; defibrillation-proof type CF applied part	IP32	Index of protection against solid foreign objects (> 2.5 mm) and dripping liquids
	Protection against electric shocks: class II.	IP41	Index of protection against solid foreign objects (> 1 mm) and dripping liquids
REF	Product reference / part number	SN	Product serial number
	Output terminal – connector		Input terminal – connector
	Direct current		Battery specification
	Alternating current		CE Marking
	Part included in a recycling process		Name and address of the manufacturer / Date of manufacture

Packaging symbols

Symbol	Description	Symbol	Description
	Fragile, handle with care		Humidity limitation
	This way up		Atmospheric pressure limitation
	Keep away from rain		General symbol for recyclable material
	Temperature limitation		Eco packaging symbol



Information:

Please refer to the Use environment section for additional information on temperature, pressure and humidity limitations.

Release Notes

Date	Software version	Description
February 2013	2.0	Creation
September 2013	2.1	This software version features a technical information menu.

Local contacts for servicing and use issues

Complete this box with your contacts:

Table of contents





1	INTRODUCTION	6
1.1	EXPLANATION OF SYMBOLS	6
1.2	SCOPE	6
1.3	INTENDED USE	7
1.4	CONTRAINDICATIONS	8
1.5	USE ENVIRONMENT	8
2	DESCRIPTION	9
2.1	SYSTEM DEFINITION	9
2.2	PACKAGING CONTENT	9
2.3	GENERAL DESCRIPTION	10
2.4	DETAILED DESCRIPTION	11
3	INSTALLATION AND REMOVAL	15
3.1	INSTALLATION	15
3.2	REMOVAL	19
4	OPERATIONS	21
4.1	USE OF INTERNAL BATTERY	21
4.2	BASIC OPERATIONS	22
4.3	PUMP MENU	35
5	CLEANING AND DISINFECTING	45
5.1	PROHIBITED CLEANING AGENTS	45
5.2	PRECAUTIONS FOR CLEANING	45
5.3	RECOMMENDED CLEANING AGENTS	45
5.4	CLEANING GUIDELINES AND PROTOCOL	46
6	QUICK CHECK PROTOCOL	48
7	ALARMS AND SAFETY FEATURES	50
7.1	ALARMS / ACTIONS	50
7.2	TROUBLESHOOTING	56
8	TECHNICAL INFORMATION	57
8.1	PERFORMANCE	57
8.2	TECHNICAL CHARACTERISTICS	59
9	TRANSPORT, STORAGE AND RECYCLING CONDITIONS	62
9.1	STORAGE AND TRANSPORT CONDITIONS	62
9.2	STORAGE	62
9.3	RECYCLING AND DISPOSAL	63

10	GUIDANCE AND MANUFACTURER'S DECLARATION ON EMC	64
10.1	ELECTROMAGNETIC COMPATIBILITY AND INTERFERENCE GUIDANCE	64
10.2	TABLE 4 - GUIDANCE AND MANUFACTURER'S DECLARATION - ELECTROMAGNETIC IMMUNITY	65
10.3	TABLE 6 - RECOMMENDED SEPARATION DISTANCES BETWEEN PORTABLE AND MOBILE RF COMMUNICATION EQUIPMENT AND PUMP	65
11	SERVICES	66
11.1	WARRANTY	66
11.2	QUALITY CONTROL	67
11.3	MAINTENANCE REQUIREMENTS	67
11.4	SERVICE POLICY AND RULES	68
12	ORDERING INFORMATION	69
12.1	WALL PLUG	69
12.2	INSTRUCTIONS FOR USE	69
12.3	GIVING SETS	69
12.4	ACCESSORIES	70
13	GLOSSARY OF TERMS	71

1 Introduction

Amika is an enteral feeding pump and disposables dedicated to enteral feeding and hydration. Amika pump and sets intended use is to deliver nutrition and hydration fluids to the patient through a feeding tube, in a safe, instinctive and convenient manner.

1.1 Explanation of symbols

Symbol	Description
	Danger: Warning of an imminent hazard that could result in serious personal injury and/or product damage if the written instructions are not followed.
	Warning symbol: Warning of a potential hazard that could result in serious personal injury and/or product damage if the written instructions are not followed.
	Caution symbol: Warning of a potential hazard that could result in minor personal injury and/or product damage if the written instructions are not followed.
	Information symbol: Recommendations to be followed.

1.2 Scope

These Instructions for Use (IFU) are applicable to the Amika pump referred to as pump with embedded **software version 2.1**.

Warning:



- *Check that these IFU are applicable to the current Amika software version.*
- *The software version of the pump is displayed on the start-up screen.*
- *The user must follow the instructions specified in this IFU. Failure to observe these instructions may result in damage to the equipment, injury to patients or injury to users. Specific texts are highlighted using the symbols described in section 1.1.*

1.3 Intended use

Make sure to have fully understood how to use the Amika pump in order to assure your safety and the patient safety. Give particular attention to the texts which are highlighted by a symbol.

- The device is a peristaltic pump dedicated to enteral feeding.
- The pump is used to administrate to patient (humans only) a volume of nutrition at a programmed flow rate.
- The pump is designed to administrate fluids through trans-nasal or percutaneous feeding tube.
- The pump is designed to administrate any kind of enteral nutrition fluids; amongst them: drinking water (still and sparkling), tea, soda, fresh water and the whole product range of ready nutrition from Fresenius Kabi.

1.3.1 Intended user population



Warning:

- *The pump must only be used by trained users both on using and cleaning the pump.*
- *Keep the pump, sets and wall plug away from unsupervised children (and animals).*

The pump can be used by healthcare professionals, patients or patient relatives.

It is recommended that users attend a single training session of about 40 minutes (training guide available from your Fresenius Kabi sales representative).

1.3.2 Intended patient population

Danger!

DANGER

The pump can be used on one patient at a time and multiple patients during its lifetime.

The pump can be used on patients requiring enteral feeding and enteral hydration.

Intended patient population includes patients who get enteral nutrition parallel to IV insulin administration. Those patients require special attention during the feeding process.

1.4 Contraindications

Danger!

DO NOT USE:

- *for the intravenous administration of infusion fluids.*
- *if enteral feeding is contraindicated by medical prescription.*
- *with premature (born < 37 weeks of pregnancy) and neonates (<1 month).*
- *in Magnetic Resonance Imaging (MRI) environments.*
- *in ambulances, helicopters, aircrafts and hyperbaric chambers.*

DANGER

1.5 Use environment

The Amika pump is intended to be used inside and outside the hospital.

The Amika wall plug is not meant to be used outdoor (e.g. in the garden, on the patio).

Warning:

- *Keep away from heat sources, dust, fluff, direct and prolonged light exposure.*
- *The Amika pump may not be operated in areas where there is a risk of explosion.*
- *The pump should be used under specified operational, storage and transport conditions listed below to ensure pump performance.*



- **Temperature operating range:** 10°C to 40°C
Storage and transport temperature: -20°C to +45°C
- **Pressure operating range:** 700 hPa to 1060 hPa
Storage and transport pressure: 500 hPa to 1060 hPa
- **Humidity operating range:** 30% to 85%,
no condensation
Storage and transport humidity: 10% to 90%,
no condensation
- **Altitude:** maximum 3000 m.

2 Description

2.1 System definition

The Amika system is composed of the following components:

- Amika pump: enteral feeding pump with pump holder and wall plug.
- Amika disposable (applied part): giving sets.
- Amika accessories.

2.2 Packaging content

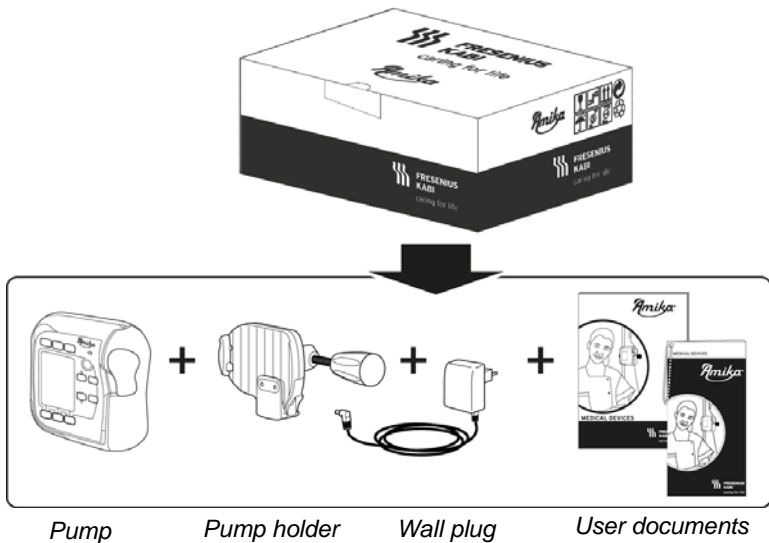

Packaging consists of: Recycled cardboard.

Symbols used on Amika packaging are described on page 2.

2.3 General description

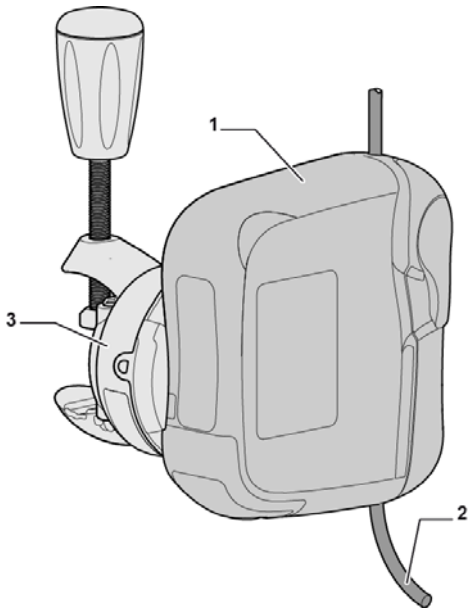

Legend:

- 1 - Pump
- 2 - Giving set
- 3 - Pump holder

2.4 Detailed description

2.4.1 Pump description

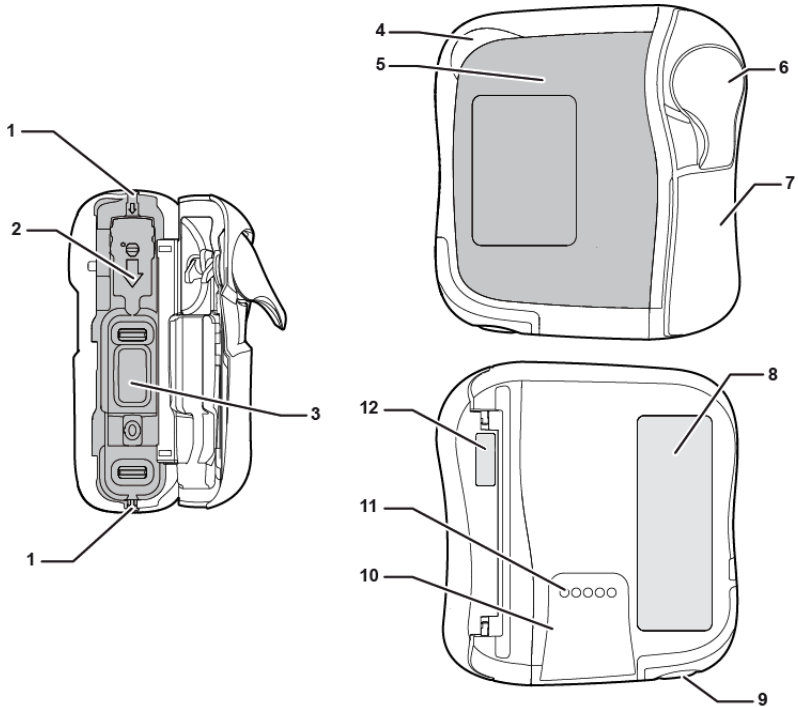

Legend:

- 1 - Tube guides
- 2 - Pinch clamp slot
- 3 - Pumping mechanism
- 4 - Status light indicator
- 5 - Front panel
- 6 - Door lever
- 7 - Pump door
- 8 - Pump identification label
- 9 - Speaker
- 10 - Rails for installation on pump holder
- 11 - Contact pins for pump to holder connection
- 12 - Pump door identification label

2.4.2 Pump holder description

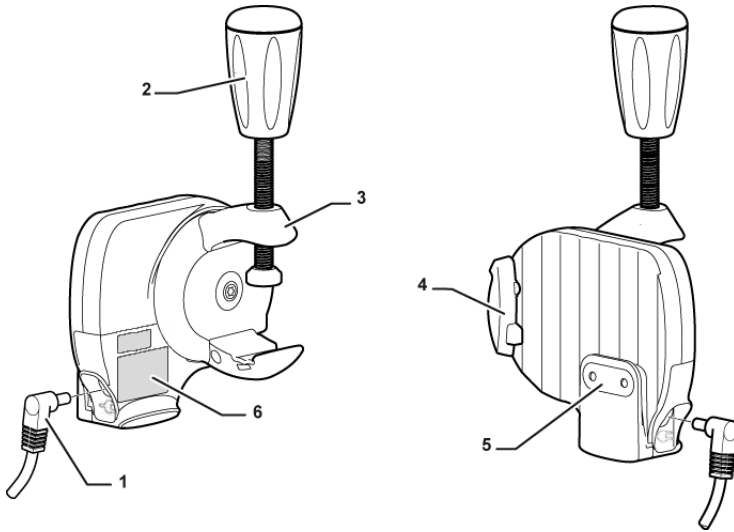

Legend:

- 1 - Wall plug DC connector
- 2 - Clamp handle
- 3 - Pole clamp
- 4 - Grey locking lever
- 5 - Contact pins for pump to holder connection (Power supply)
- 6 - Holder identification labels

Symbol	Location	Symbol description
	Near the power cable inlet of the holder	Please see section 8.2.2

2.4.3 User interface description

2.4.3.1 Front panel description

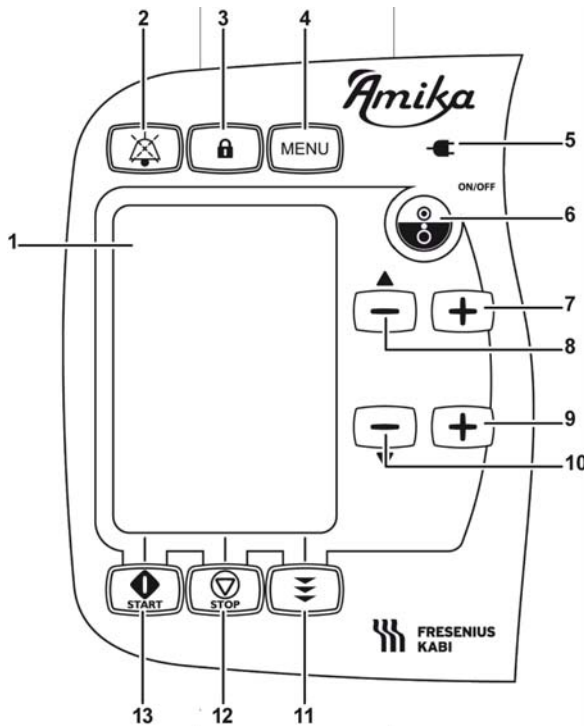







Legend:

- 1 - Display (description next page)
- 2 - Mute (alarm silence) key
- 3 - Keypad lock key
- 4 - Menu key
- 5 - Mains supply light indicator
- 6 - Power ON/OFF key
- 7 - Flow rate Up (+)
- 8 - Flow rate Down (−) / Scroll up in Menu (▲)
- 9 - Target volume Up (+)
- 10 - Target volume Down (−) / Scroll down in Menu (▼)
- 11 - Priming function key
- 12 - Stop / Cancel / Back key
- 13 - Start / Enter / OK key

2.4.3.2 Display description

Status Bar icons

	Sound level icons		Alarm icon
	Battery icon		Muted alarm icon
	Keypad locked		Settings lock icon

Setting screen layout

Pumping status indicator:



Pumping is stopped



Pumping is in progress

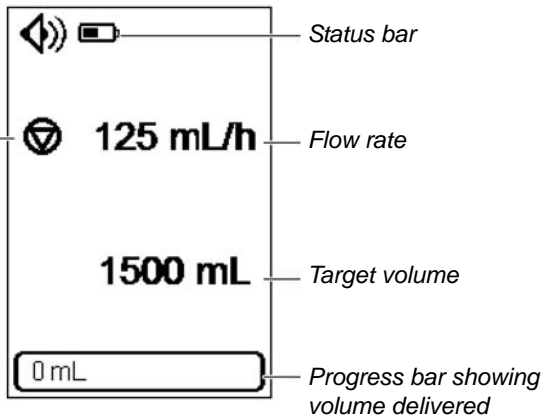

Menu display layout

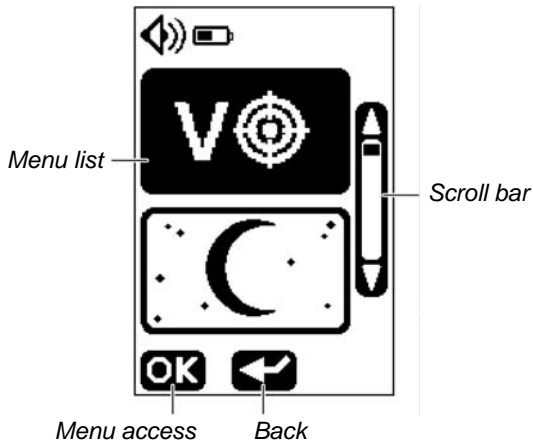

3 Installation and removal

3.1 Installation

3.1.1 Global installation

Danger!

DANGER

Respect the appropriate positions between patient, pump, giving set and container. Check the stability of the whole system. If the container is positioned lower than 0.5 meter beneath the pump, this can lead to flow rate deviation.



Warning:

Give particular attention to the risk of strangulation with cables and sets.

Recommended installation

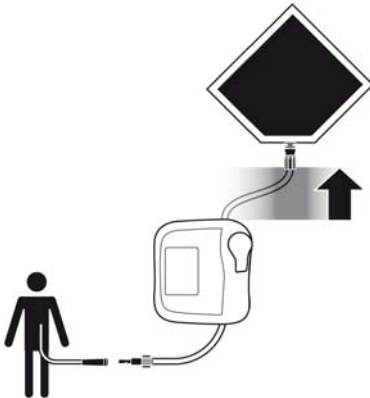

Place the container above the pump

Possible installation

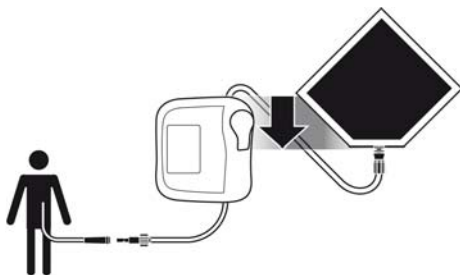

The container can be placed down to 0.5 m beneath the pump

3.1.2 Using the pole clamp

The holder can be attached universally, vertically and horizontally. Turn the pole clamp to the suitable position.

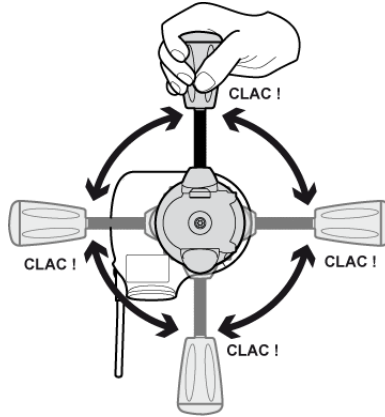

3.1.3 Positioning the holder on a rail or pole

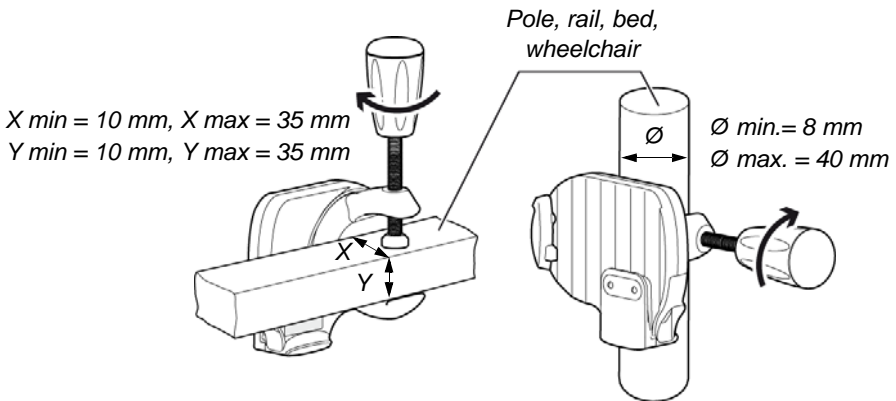

Ensure the holder is positioned so that the display is at the suitable height to ensure good visibility and orientation in the reading direction (the contact pins are at the bottom).



Warning:

- Fasten pole clamp firmly on the pole or rail to avoid any movement of the pump.
- Ensure that the pump is securely attached and positioned.

3.1.4 Positioning the holder on a table

The holder can be placed on a flat and horizontal table as indicated in the figure below.

Ensure the pump is positioned away from table edges to avoid being accidentally pushed off the table.

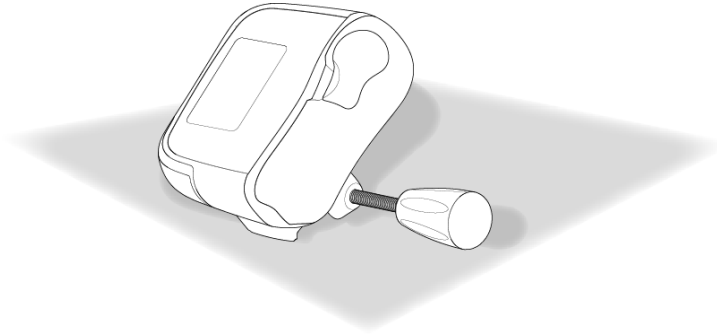

3.1.5 Positioning the pump

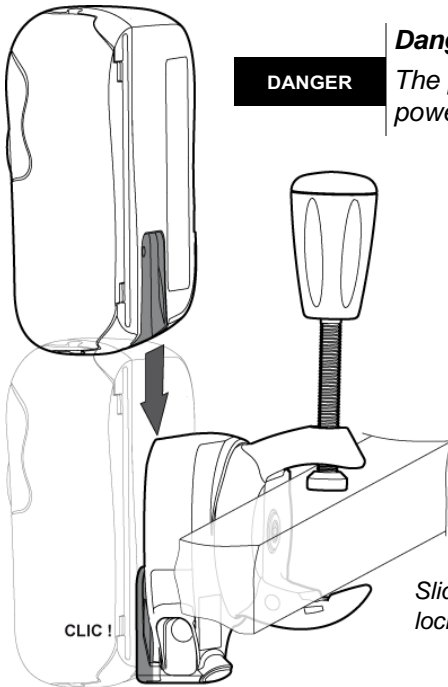

Danger!

DANGER

The pump is only compatible with its own power support (pump holder and wall plug).

Slide the pump down until the grey locking lever locks the position.

3.1.6 Electrical connection

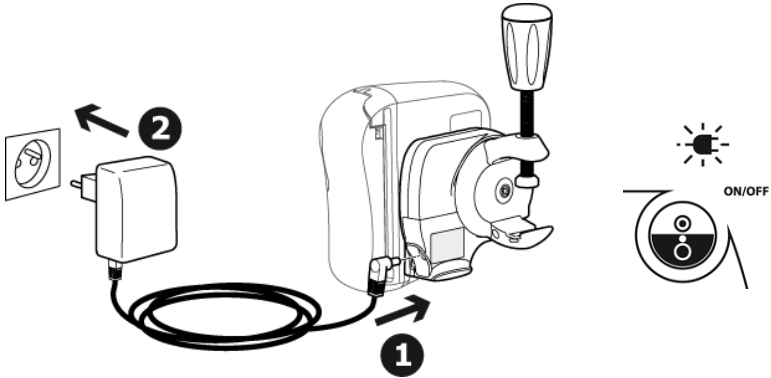

- 1 Connect wall plug DC connector to the holder
- 2 Plug the wall plug to the mains socket

When connecting to the mains, ensure that the wall plug and the power socket are easily accessible.

The mains power supply is indicated by a green light on the pump front panel.



Warning:

Ensure wall plug is not damaged and compatible with local voltage range.

3.2 Removal

3.2.1 Removing the pump from the pump holder

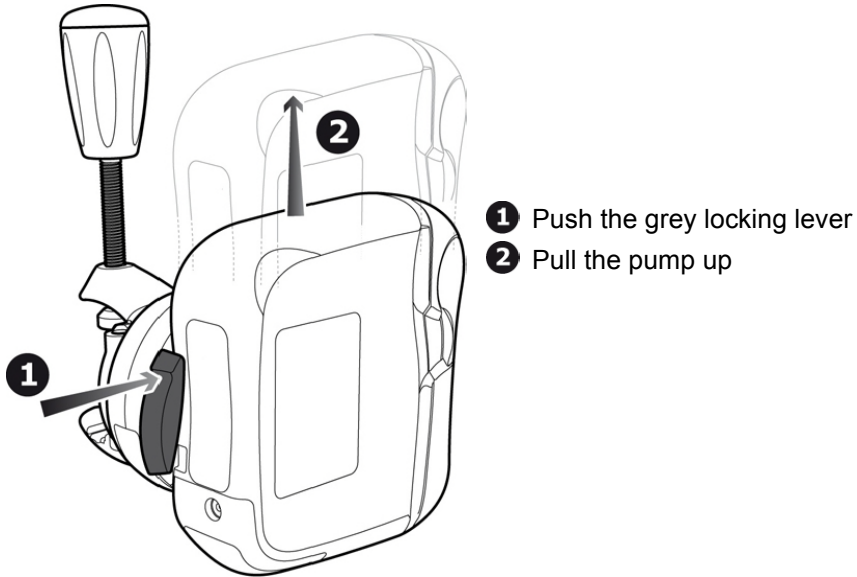

3.2.2 Removing the pump holder

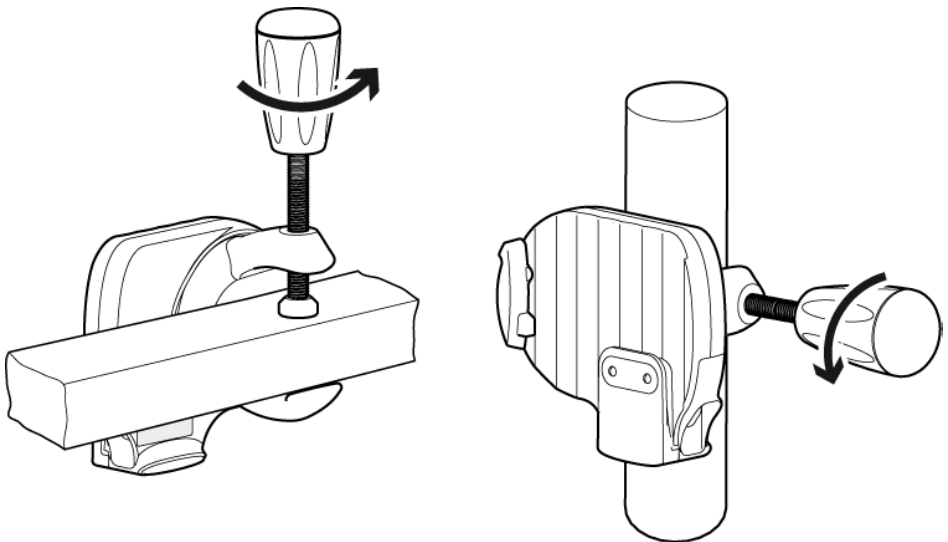

3.2.3 Electrical disconnection

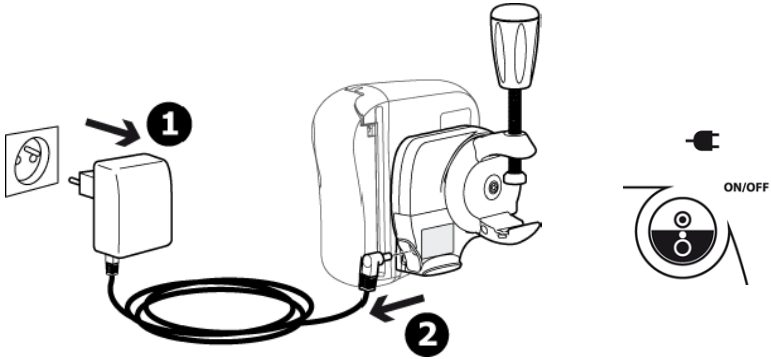

- 1 Remove wall plug from mains socket
- 2 Remove wall plug DC connector from holder

Information:



- A beep is emitted by the pump when the wall plug is disconnected.
- To store the pump, see section 9.2.

3.2.4 Attaching / Removing the Quick Guide

A quick guide can be easily attached and removed from the pump holder.

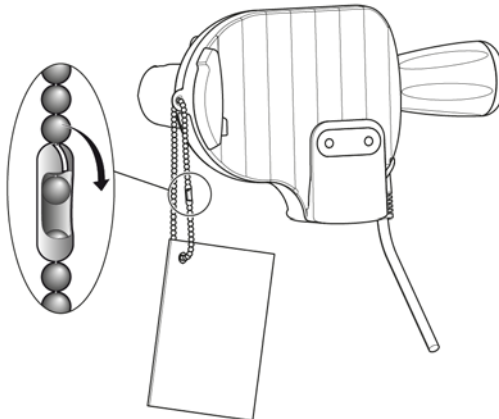

4 Operations

4.1 Use of internal battery

4.1.1 Battery precautions







Warning:

- Before using the pump on battery for the first time, charge the battery until it is fully charged (approximately 6 hours).
- Keeping the pump connected to mains when not in use is recommended in order to maintain battery charge.

4.1.2 Battery operating mode

The icon  is always displayed in the status bar.

Device can be used while battery is charging.

Battery life	24 hours \pm 5% at 125 mL/h
 (green)	When the pump is connected to the mains (see section 3.1.6) ▶ Battery charges automatically, also during operation
	When the pump is disconnected from the mains (see section 3.2.3) ▶ Pump switches to Battery Mode automatically
	The battery is fully charged
	The battery is partially charged
 (flashing)	The battery is nearly empty. ▶ A message is triggered. When battery is empty (less than 10 minutes left), an alarm is triggered (see section 7.1).



Information:

- To optimize battery life, set the flow rate at 125 mL/h maximum and use the pump in battery mode several times until battery is discharged (🔋 flashing).
- If battery is failing, do not use the device. Return device to Fresenius Kabi After-Sales Service as soon as possible.
- Battery replacement must be performed by qualified and trained technical personnel in compliance with the technical manual and procedures.

4.2 Basic operations

Before using the pump, proceed to Quick Check Protocol (see section 6).

4.2.1 Switch-on



Warning:

- For patients requiring special attention, another pump must always be available. It is also recommended to have a gravity set available.
- When switching on the pump, check that the auto test sequence is as described below.

Before switching on the pump, install holder and pump, (see section 3.1).

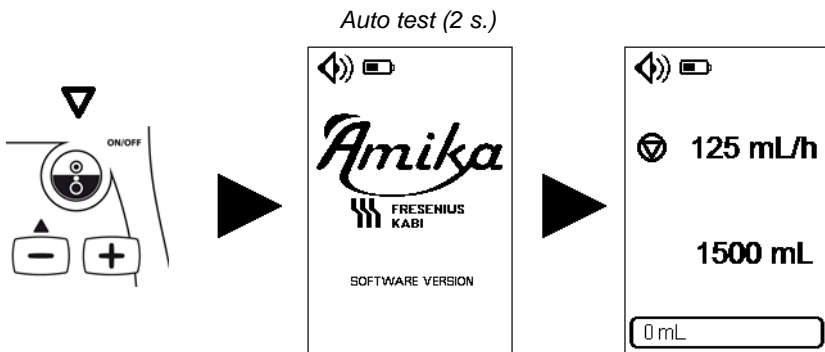

During the autotest of 2 seconds:

- Red, yellow and green LEDs blink
- Beep sounds (if sound level is low, melody is playing on low, if sound level is high, melody is on high)

4.2.2 Installing the giving set

4.2.2.1 Preparing the giving set

Danger!

DANGER

In order to protect users health, please follow clean aseptic handling procedure for containers, sets or feeding tubes disposal.



Warning:

- *Only Fresenius Kabi giving sets can guarantee pump reliability. Please refer to the compatible giving sets (see section 12.3) and compatible nutrition fluids (see section 1.3).*
- *Check the giving set intended use regarding the feeding protocol, especially for patients requiring special attention.*
- *Check giving set and patient connection integrity before use.*



Caution:

The fluid in the giving set and the bag/bottle must be within normal temperature conditions: +10°/+40°C.

4.2.2.2 Description of the pinch clamp

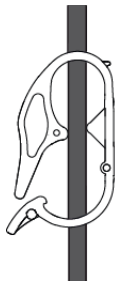

Pinch clamp is open



Pinch clamp is closed



Information:

Patient must not be connected to the set when pinch clamp is open.

4.2.2.3 Installing the giving set in the pump

To connect / disconnect / change the container and feeding tube to the set, refer to the giving set "Instructions for use".



Warning:

For patients requiring special attention, another giving set must always be available.

A

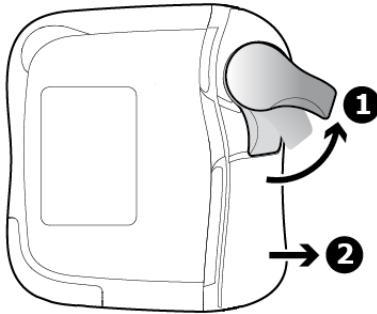

1 Push up the lever to unlock the door.

2 Open the door.

B

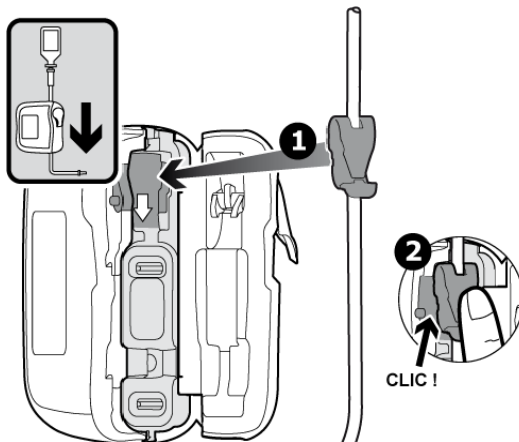

1 Position the pinch clamp using the arrow marks indicating the direction of the flow.

2 Insert the pinch clamp until obtaining the 'CLIC'.

C

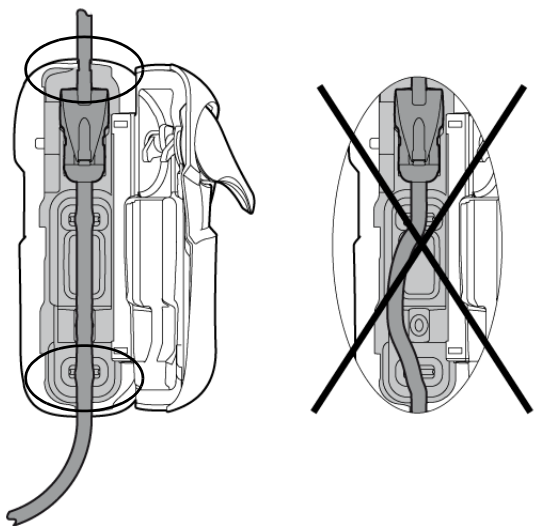

Place the tube straight inside tube guides.

DANGER

Danger!

Check that the giving set is correctly installed to avoid risks (free-flow, air in line, reverse flow, occlusion).

D

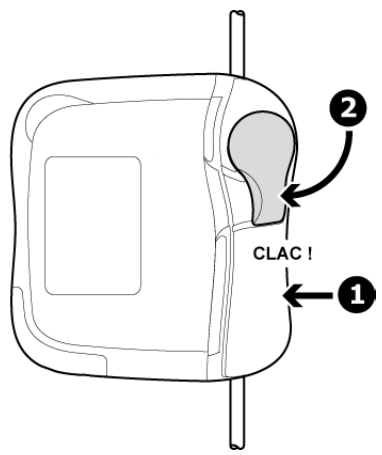

- 1** Close the door.
- 2** Push down the lever to lock the door.



Information:

When opening the pump door, the tube clamp is automatically closed (free-flow prevention system).

4.2.3 Priming the giving set



Warning:

Patient must not be connected to the pump when priming is performed.



Information:

- *To proceed to giving set priming, fill drip chamber half full by pressing gently.*
- *Check liquid is flowing in the drip chamber after starting the pump.*
- *For giving sets without drip chamber, use only automatic priming.*
- *Beep sound will be heard every 30 seconds during priming.*

4.2.3.1 Priming with the pump

Amika pump allows two priming modes:

- **Automatic priming:** Amika pump automatically fills in the giving set at maximum rate by depressing the automatic priming key.
- **Semi-automatic priming:** Amika pump fills in the giving set at maximum rate as long as the semi-automatic priming key is kept depressed.

Make sure that priming is correctly completed before starting feeding.

Automatic priming

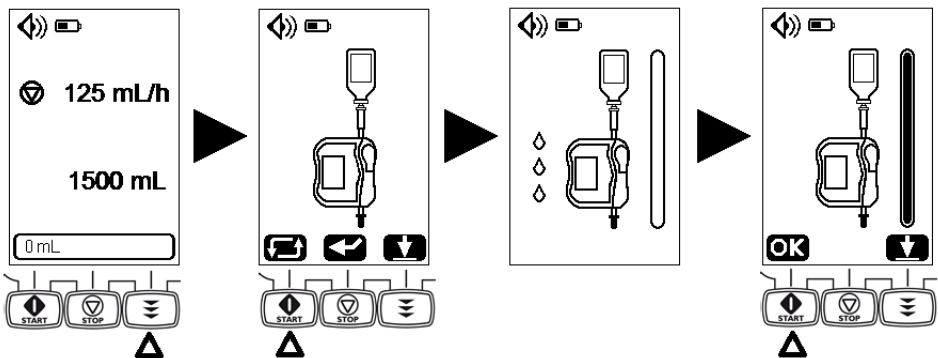

Auto priming can be stopped at any time:

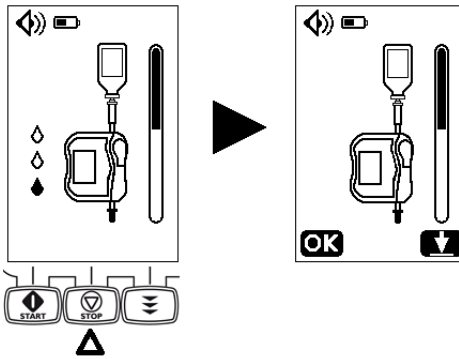

At the end of automatic priming, it is possible to continue the priming using the semi-automatic priming function as defined below.



Information:

Automatic and semi-automatic priming fill the giving set at a rate of 600 mL/h and are stopped after 17 mL (factory settings).



Warning:

Two consecutive automatic priming can cause an overflow.

Semi-automatic priming

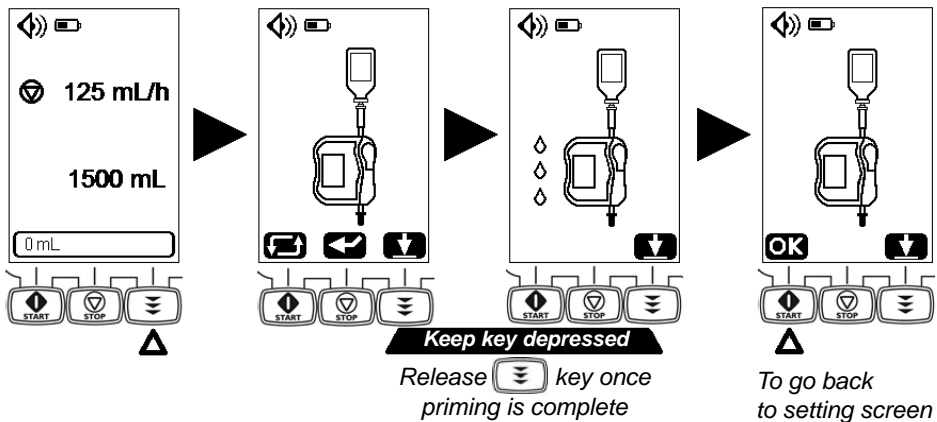

Warning:

At the end of priming, check that the set is correctly primed.

4.2.3.2 Priming without the pump (Manual priming)

Remove the giving set from the pump (see section 4.2.8).

- 1 Close pinch clamp
- 2 Connect food container to giving set and hang up
- 3 Fill drip chamber half full by pressing gently
- 4 Open pinch clamp
Prime to the end of the giving set
- 5 Close pinch clamp

Install the set in the pump to start feeding (see section 4.2.2).

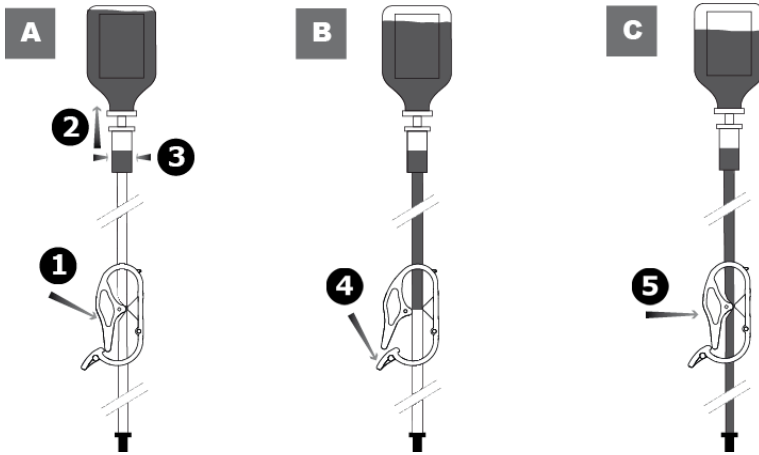

4.2.4 Change feeding setting



Information:

- A longer keypress provides faster scrolling.
- The flow rate of delivery must be adapted individually to the patient. Regular checks are required.

4.2.4.1 Adjust feeding rate (mL/h)

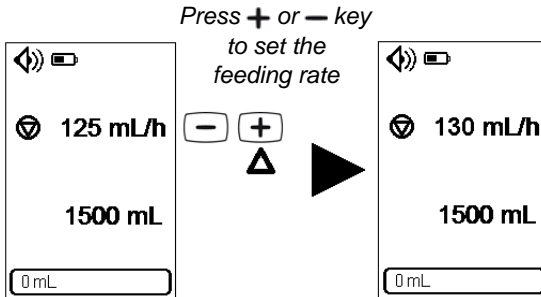

4.2.4.2 Adjust target volume (mL)

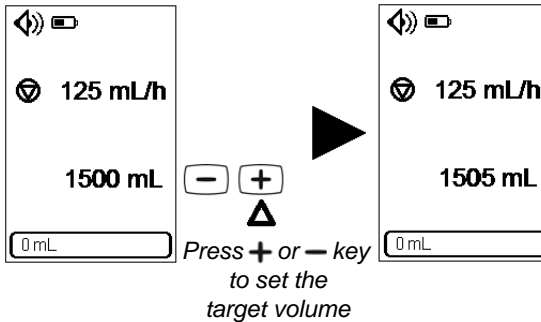

Warning:

Make sure feeding parameters are checked before starting feeding (programming error can lead to incorrect therapy).

4.2.5 Start feeding

Connect the giving set to the patient's enteral feeding tube.

Make sure that priming is correctly completed before starting feeding.



Warning:

Check power supply before starting feeding:

- green light indicator if supplied by mains, or
- battery icon filled up if supplied by the battery.

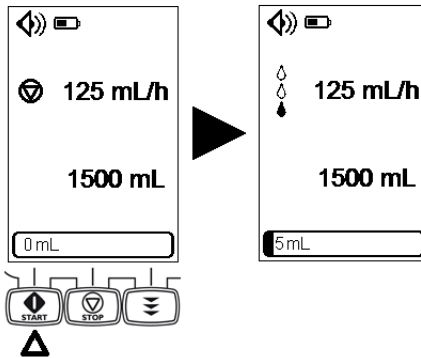

4.2.6 Terminate feeding

4.2.6.1 Stop feeding

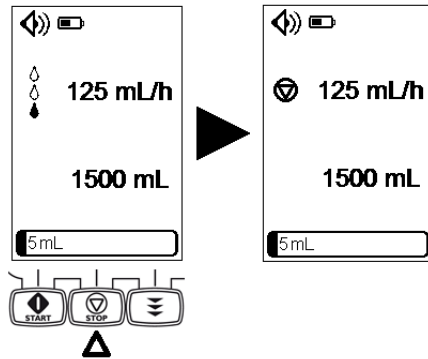

When feeding is stopped, flow rate and target volume parameters can be adjusted. Then, feeding can resume.

4.2.6.2 Stop feeding and reset the progress bar

Progress bar can be reset by depressing the  key for 2 seconds.

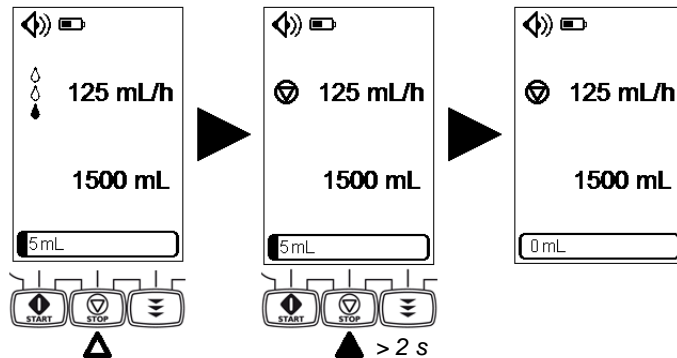

4.2.7 Switch off pump

The feeding shall be stopped before switching off the pump.

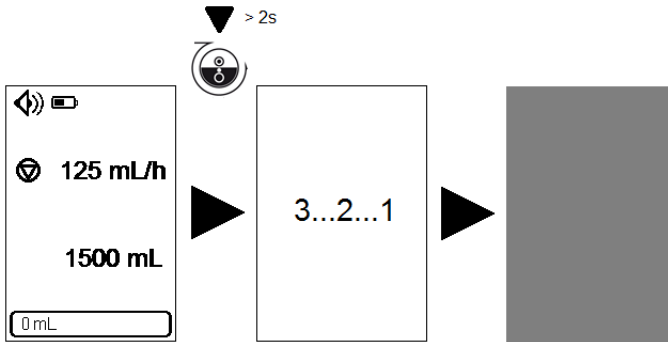

Information:

- When feeding is on-going,  key is inactive: forbidden key beep is triggered but feeding continues.
- When switched off, the pump retains the following information:
 - Flow rate, volume and progress bar on the setting screen,
 - Cumulative feeding volume,
 - Target volume mode,
 - Sound level, key beep activation / deactivation
 - Contrast and brightness
 - Feeding and Alarm history,
 - Settings lock activation / deactivation,
 - Time between 2 alarm sounds,
 - Time for target volume almost reached message.
 - Technical information
- This information is saved even if the battery is disconnected with no time limit.



4.2.8 Removing/Changing the giving set from the pump



Warning:

- Giving set is single used disposable and must be changed every 24 hours.
- For patients requiring special attention, another giving set must always be available.

A

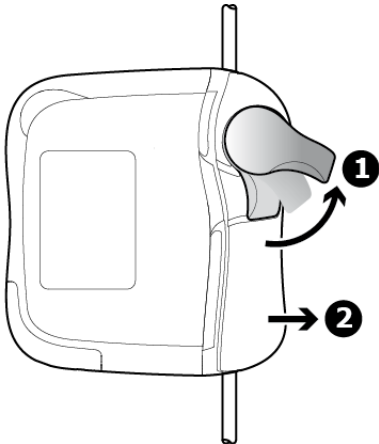

- 1 Push up the lever to unlock the door.
- 2 Open the door.

B

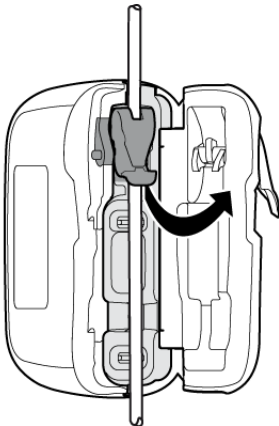

Remove giving set.

Install a new giving set in the pump (see section 4.2.2).

4.2.9 Keypad lock



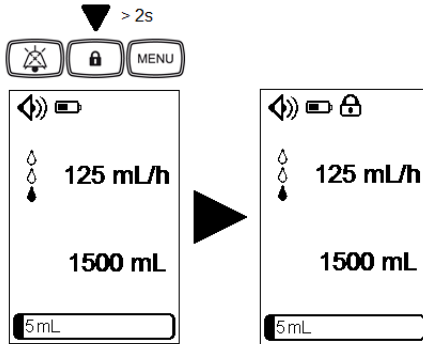

Warning:

Keypad lock prevents from unintentional tampering of pump settings.



When keypad is locked:

-  is displayed in the status bar
-  is the only active key. If other keys are depressed, forbidden key beep is triggered, no action is undertaken and feeding continues.

Keypad can be unlocked by depressing the keypad lock key  for 2 seconds.

Unlocking the keypad is required to stop feeding, change feeding settings and enter the menu.

4.2.10 Mute alarm

To release temporarily alarm sound, press .

When an alarm is muted:

- The mute icon  is displayed in the status bar,
- The alarm symbol keep being displayed and yellow LED keep flashing until a corrective action is performed.
- Alarm sound is off during 2 minutes.

When prior information to alarm is muted:



- It switches off the sound until the alarm occurs.

For further information about alarms, see section 7.1.

4.3 Pump menu



Information:

- Menu is accessible when feeding is stopped.
- A beep sound is triggered when a forbidden key (not active in specific screens) is depressed.
- During a procedure, press  (OK) to validate the choice and go back to the setting screen.
- Press  () to go back to previous screen (without validation).

4.3.1 Access menus

Menus description

Menus	Description
Target volume mode	Deactivate / activate target volume mode (Access code is required, if settings lock activated)
Night mode	Night mode activation / deactivation
Sound	Adjust sound level
	Deactivate / activate key beep
Settings lock	Deactivate / activate settings lock
Cumulative feeding volume counter	Display cumulative feeding volume
	Clear cumulative feeding volume
Alarm history	Consult the 250 last alarm events
Feeding history	Consult the 250 last feeding events
Contrast / Brightness	Contrast setting
	Brightness setting
Time between 2 alarm sounds	Consult time between 2 alarm sounds
	Set time between 2 alarm sounds (Access code is required)
Time for target volume almost reached message	Consult time for target volume almost reached message
	Set time for target volume almost reached message (Access code is required)
Technical information	Consult technical information of the pump

Menu navigation

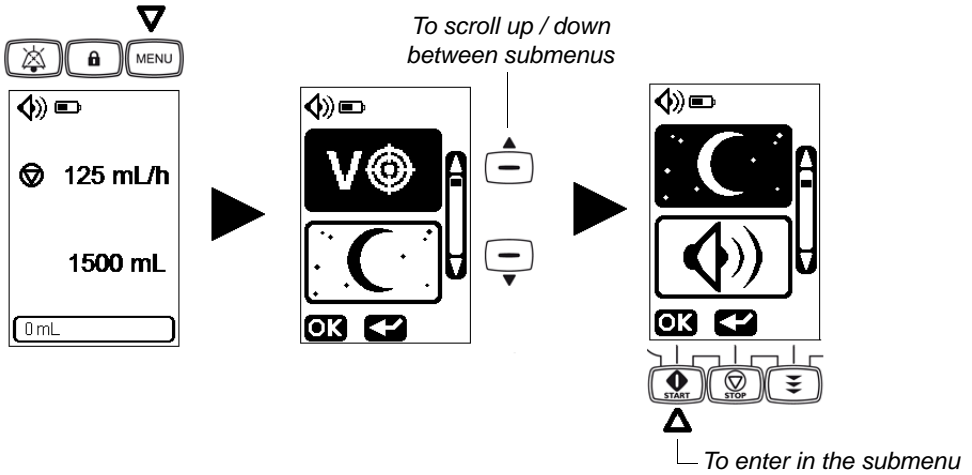

4.3.2 Target volume mode

On this screen, target volume mode is deactivated .

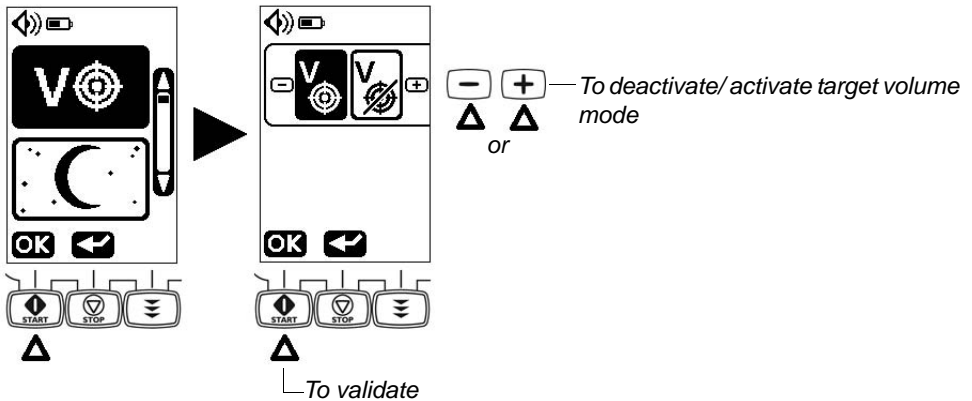

Information:



- When target volume mode is deactivated, the target volume and the progress bar disappear from the display.
- If settings lock is activated, access code is required to activate / deactivate target volume.

4.3.3 Night mode

On this screen, night mode is activated .

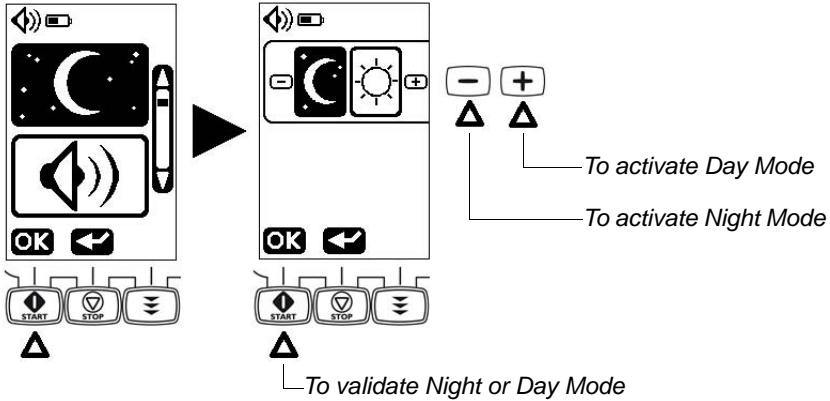



Information:



- When night mode is activated, display backlight and power LED are set to minimum level.
- In case of alarm, the backlight turns back to normal.
- Night mode is automatically deactivated after switching OFF the pump.

4.3.4 Sound

The pump is set by default to the highest sound level  (75 dB). It can be reduced to a lower sound level  (50 dB).

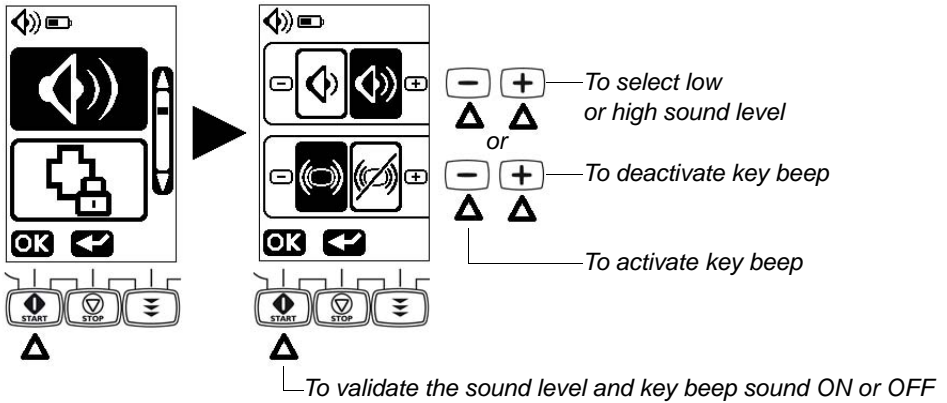

Warning:



Audible alarm signals level is adjustable. However, please ensure the user can hear alarms, especially when the pump is used on battery.

4.3.5 Settings lock

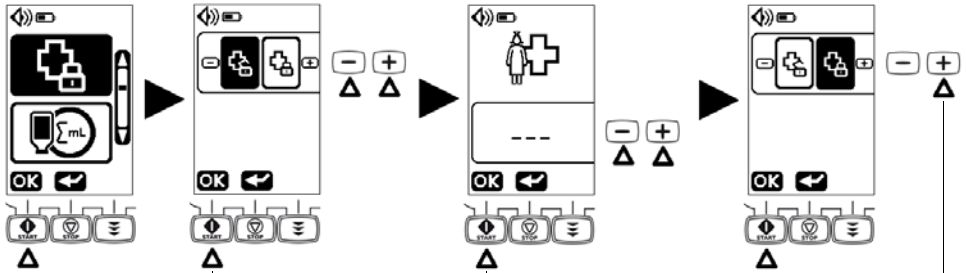

Press key to activate Settings lock

Adjust each digit (0 to 9) of the access code using + and - keys and validate each by pressing OK.

To activate settings lock function

When settings lock is activated:

-  is displayed in the status bar.
- Target volume and flow rate cannot be changed
- Accessible keys are:

     ,  with restrictions.

Information:

- To get the access code, contact your Fresenius Kabi sales representative.
- Settings lock activation / deactivation isn't modified after switching OFF the pump.
- When settings lock is activated, keypad lock can still be activated / deactivated.



4.3.6 Cumulative feeding volume counter

4.3.6.1 Accessing cumulative feeding volume

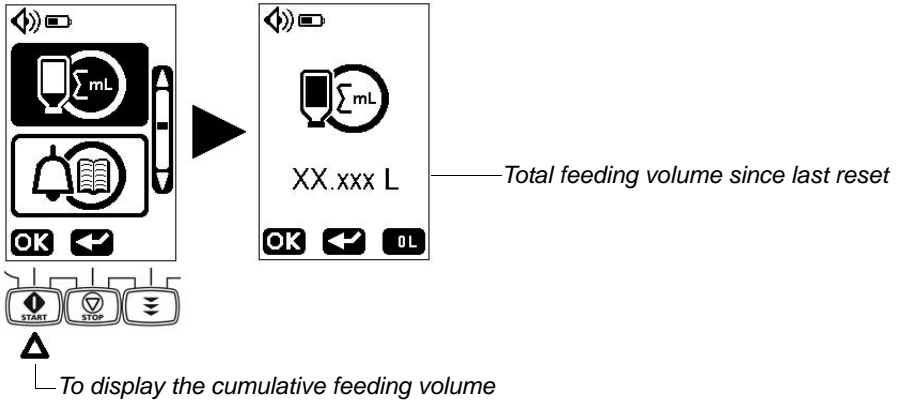

4.3.6.2 Clearing cumulative feeding volume

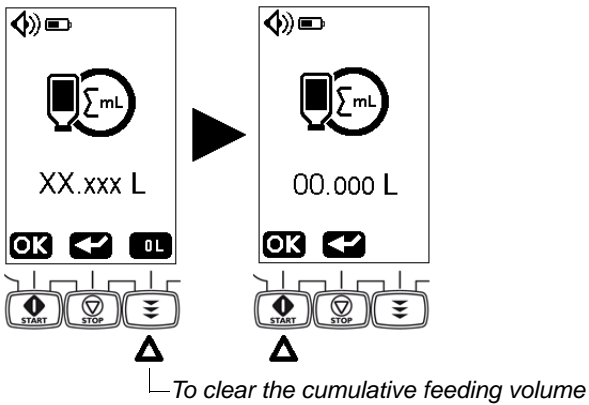

4.3.7 Alarm history

Alarm events are automatically saved in the pump memory.

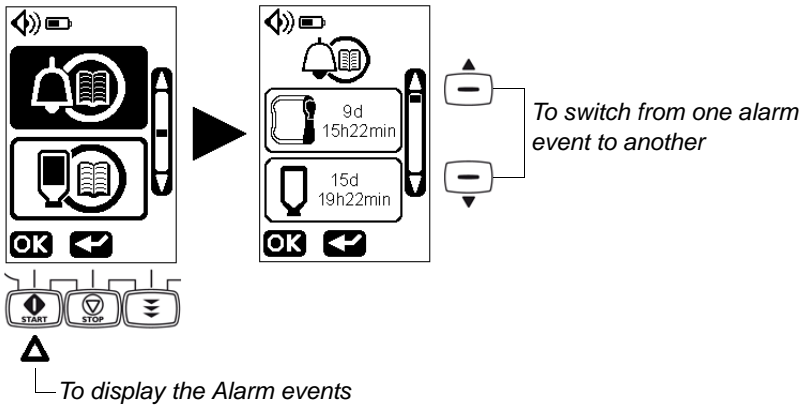

Information:

Alarm history indicates the type of alarm and the time elapsed since event happened.



Example: 'A battery alarm occurred 9 days, 15 hours and 22 minutes ago.'

4.3.8 Feeding history

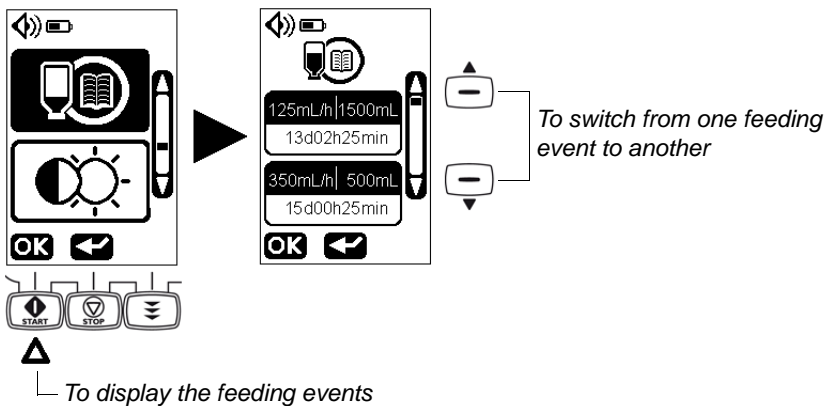

Information:

Feeding history indicates the delivered volumes, their associated flow rate and the time elapsed since their delivery.



Example: 'A volume of 1500 mL was administered at a flow rate of 125 mL/h, 13 days, 2 hours and 25 minutes ago.'

4.3.9 Contrast / Brightness

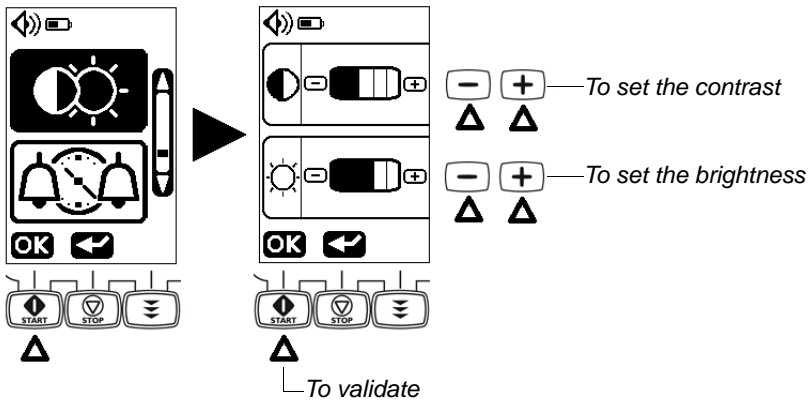

4.3.10 Set time between two alarm sounds

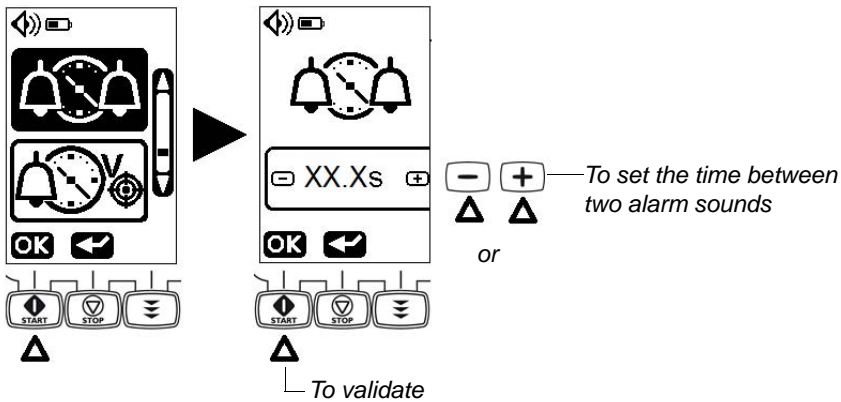

Information:

Access code is required to set time between two alarm sounds.



Warning:

Time between 2 alarms can be adjusted from 2.5 to 30 seconds with steps of 0.5 second. This adjustment can modify the perception of an alarm.

4.3.11 Set time for target volume almost reached message

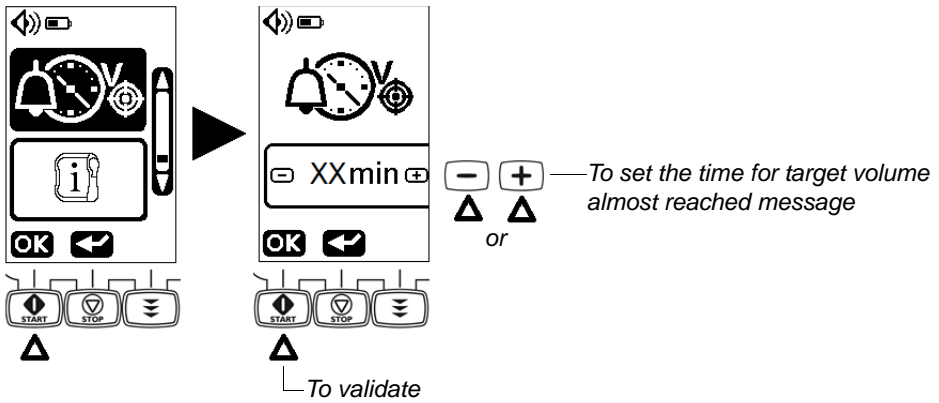

Information:



- Time between target volume almost reached message and target volume reached alarm can be adjusted from 0 to 59 min., with steps of 1 min.
- Access code is required to set time for target volume almost reached message.

4.3.12 Technical information

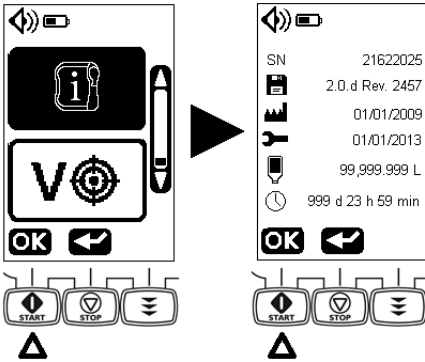

Information:

- *The technical information menu displays:*

SN *Pump serial number*

 *Software version*

 *Production date (mm/dd/yyyy)*

 *Last maintenance date (mm/dd/yyyy)*

 *Total delivered volume*

 *Total functioning time*



5 Cleaning and disinfecting

5.1 Prohibited cleaning agents

Do not use cleaning or disinfecting agents that contain the following substances as these aggressive agents may damage the plastic parts of the device and cause the device to malfunction.

- Trichloroethylene.
- Abrasive detergents.

The Amika pump is not intended to be sterilized. Sterilization may result in damages to the device.

5.2 Precautions for cleaning

Clean pump and pump holder as soon as they became contaminated with tube feed or drugs, and at least once a week.

After cleaning, the pump should be left to dry for approximately 5 minutes before being started or reconnected to the mains.

Danger!

DANGER

- *The pump must be cleaned after each patient usage by a trained nurse or nurse assistant.*
- *Please follow the disinfecting and cleaning best practices to limit risks of pump damage.*

5.3 Recommended cleaning agents

For cleaning and disinfecting, the following combination agents are recommended:

- DDSH – Manufacturer: Anios laboratory
- Incidin Rapid
- Bacillol AF
- Cleansept wipes
- Incidin Active - Manufacturer: Ecolab
- Dismozun - Manufacturer: BODE

Please contact the appropriate service, responsible for cleaning and disinfecting products in your establishment for further details.

5.4 Cleaning guidelines and protocol

5.4.1 Pump and pump holder



Information:

- Do not immerse pump and pump holder in liquids or let liquids entering device's housing.
- Pump and pump holder are resistant to recommended cleaning agents (see section 5.3).



- Switch off pump (see section 4.2.7), and disconnect it from the mains (see section 3.2.3).
- Wipe down pump and pump holder with a damp cloth or a cloth soaked in disinfectant.
- Clean contact pins with cotton wool soaked in disinfectant if required.

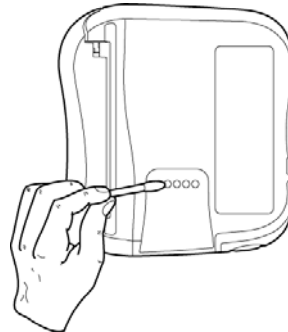

5.4.2 Pump mechanism and sensor area

- Remove pump from holder (see section 3.2.1), and open the pump door (see section 4.2.2).
- Clean the sensor area and the clamp fixture with a cloth soaked in disinfectant or follow local hospital policy.
- Wipe the pump mechanism with a damp cloth.

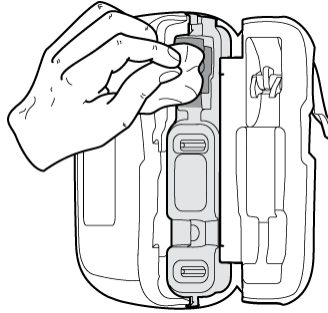

5.4.3 Pump door

- Remove the door from the anchoring.
- Clean it separately with running water. Note that door can be immersed.

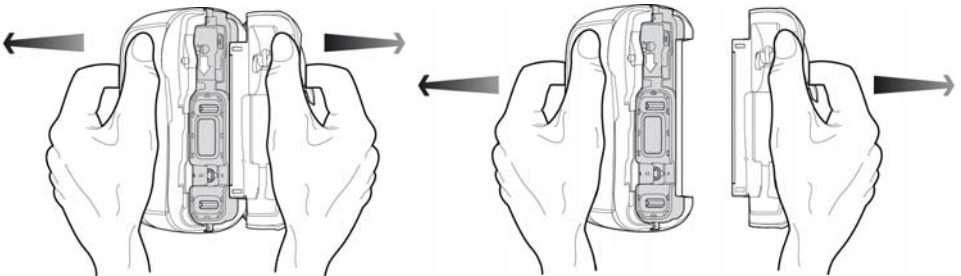

Warning:

Make sure to use the original door when replacing it on the pump (check the serial number on the pump is the same as on the door). A door switch between pumps can lead to major pumping errors.

6 Quick check protocol



Warning:

- *The following checks allow users to confirm device behaviour according to these instructions for use. Fresenius Kabi recommends performing these tests before connecting Amika pump to patients.*
- *If one or more checks do not comply with the right pump behaviour, please contact the appropriate department or Fresenius Kabi After-Sales Service for additional verification.*

Action	Yes <input checked="" type="checkbox"/>
Before use	
1 - Check if the Amika pump, holder and wall plug are not damaged in any way	<input type="checkbox"/>
2 - Check the general state of the display	<input type="checkbox"/>
3 - Install the Amika pump on the holder	<input type="checkbox"/>
4 - Connect holder to the mains	<input type="checkbox"/>
5 - Switch on the pump	<input type="checkbox"/>
6 - Check the autotest sequence (LCD display intact, speaker, LED and the back light)	<input type="checkbox"/>
7 - Check the mains LED lights up	<input type="checkbox"/>
8 - Remove the Amika from the holder and check the battery symbol on the display	<input type="checkbox"/>
9 - Install the Amika pump on the holder	<input type="checkbox"/>
10 - Check that the pump and its holder are securely attached or positionned	<input type="checkbox"/>
11 - Connect a set to a filled container, install the set in the pump and close the door	<input type="checkbox"/>
12 - Prime the set	<input type="checkbox"/>
13 - Set at the prescribed flow rate and target volume	<input type="checkbox"/>
14 - Start feeding	<input type="checkbox"/>
15 - Check the feeding information (droplet animation)	<input type="checkbox"/>
16 - Check that pumping is effective	<input type="checkbox"/>

Action	Yes <input checked="" type="checkbox"/>
After use	
1 - Check if pump, holder and wall plug are not damaged in any way	<input type="checkbox"/>
2 - Clean the pump, holder and wall plug	<input type="checkbox"/>
3 - Check the membrane of Amika pump is intact (no cracks, no wear)	<input type="checkbox"/>
Once per year	
Check the following alarms and messages (symbol on the display, beep sound, status light indicator blinking)	
1 - Set installation alarm	<input type="checkbox"/>
2 - Door alarm	<input type="checkbox"/>
3 - Upstream occlusion alarm	<input type="checkbox"/>
4 - Downstream occlusion alarm	<input type="checkbox"/>
5 - Empty bag / Air in Line alarm	<input type="checkbox"/>
6 - Target volume almost reached message	<input type="checkbox"/>
7 - Battery nearly empty message	<input type="checkbox"/>
8 - Check the flow rate by measuring the delivered volume	<input type="checkbox"/>

7 Alarms and safety features

7.1 Alarms / Actions

The Amika pump has a continuous inspection system that operates as soon as it is in use.





It is recommended that the user is positioned in front of the Amika pump, for best visibility of alarm display.

Danger!



DANGER

Please make sure the appropriate reaction to alarm is undertaken. A wrong or delayed reaction leads to a delay of therapy.

7.1.1 The different types of information signal or alarm

Information signal sound (1 beep)		Forbidden key information	Feeding continues
Flashing yellow led and alarm sound (sequences of 1 beep)		Prior information to alarm	Feeding continues
Flashing yellow led and alarm sound (sequences of 3 beeps)		Functional alarm	Feeding stops
Flashing yellow led and alarm sound (sequences of 3 beeps with a louder beep)		Technical alarm	Feeding stops
Flashing red led and buzzer sound		Fail safe technical alarm	Feeding stops

When a functional alarm or prior information to alarm occurs:

- To mute alarm sound, press , see section 4.2.10.
- Detect the specific problem causing the alarm or prior information to alarm condition, by looking at the drawing displayed on the pump.
- To release alarm, press .
- Make a corrective action (see following table).
- Restart feeding using the  key.





Warning:

Identify displays, symbols and status in the table below, to understand the meaning and conduct the appropriate action.

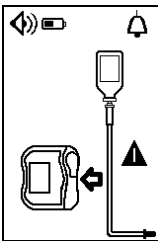
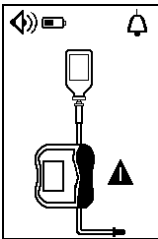
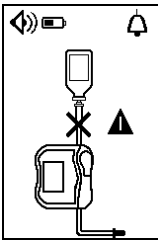
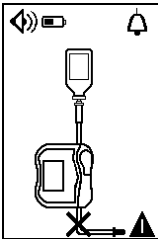
7.1.2 Alarms description

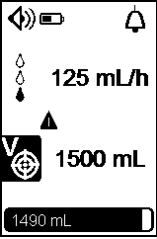
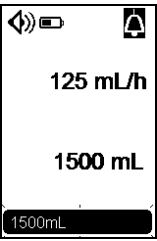
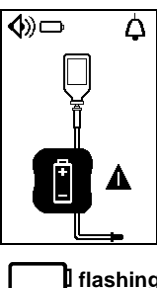
Symbol	Meanings	Actions
Control of line		
Giving set 	<p>Missing giving set or giving set not properly installed or wrong set installed.</p> <p>Area where pinch clamp is inserted is contaminated.</p>	<ul style="list-style-type: none"> ▪ Check position of giving set above and below the pump mechanism and insert correctly if necessary. ▪ Check that the proper set is used (Amika giving sets only) ▶ see section 4.2.2. ▪ Remove dirt with cloth and soapy water or as directed by hospital policy. ▪ Allow the pump to dry. ▶ see section 5.4.2.
Door open 	<p>Pump door not properly closed at start.</p> <p>Pump door opened after start.</p> <p>Pump door removed from its anchoring.</p> <p>Door mechanism is faulty.</p>	<ul style="list-style-type: none"> ▪ Close pump door. ▶ see section 4.2.2. ▪ Close pump door. ▶ see section 4.2.2. ▪ Re-hang door. ▪ Contact your biomedical department.
Upstream occlusion 	<p>Upstream flowpath is blocked between the container and the pump.</p>	<ul style="list-style-type: none"> ▪ Open the door, check set installation. ▶ see section 4.2.2. ▪ Check that the set is not kinked. ▪ Check that upstream clamp is open. ▪ Flush tube if necessary. ▪ Check the absence of upstream / downstream occlusion in the line.
Downstream occlusion 	<p>Downstream flowpath is blocked after the pump, at the patient side.</p>	<ul style="list-style-type: none"> ▪ Open the door, check the set installation, close the door. ▶ see section 4.2.2. ▪ Check that the set is not kinked. ▪ Re-position and verify that food flows freely after adjustment. ▪ Check that the feeding tube is clear. ▪ Flush tube if necessary. ▪ Check the absence of upstream / downstream occlusion in the line.

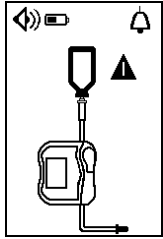
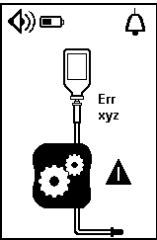
Symbol	Meanings	Actions
Control of feeding		
<p>Target volume almost reached</p> 	<p>Prior information to alarm Target volume will be reached.</p>	<p>The time of message before target volume is reached can be set in the menu. ▶ see section 4.3.11. ▪ End feeding or continue feeding.</p>
<p>Target volume reached</p> 	<p>Alarm The target volume is reached. (Complete progress bar and yellow led are flashing)</p>	<p>▪ End feeding or proceed to the next step.</p>
Functioning control		
<p>Battery empty</p> 	<p>Prior information to alarm Minimum battery voltage is not available.</p>	<p>This message appears 30 min before the empty battery alarm. ▪ Connect the pump to the mains via the pump holder. Recharge battery to resume pump operation.</p>
<p>Alarm Minimum battery voltage is not available.</p>	<p>This alarm appears 10 min before battery is fully discharged. ▪ Connect the pump to the mains via the pump holder. Recharge battery to resume pump operation.</p>	

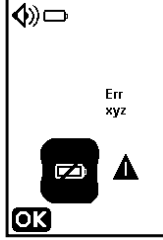
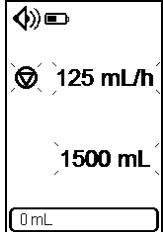
Symbol	Meanings	Actions		
Empty bag / Air in line	Feed container is empty.	<ul style="list-style-type: none"> End feeding or connect to a filled feed container. 		
	Air is in the giving set.	<ul style="list-style-type: none"> Fill giving set to the end. ▶ see section 4.2.3. 		
	Dirt in sensor area (lower tube guide).	<ul style="list-style-type: none"> Open the door and remove dirt with cloth and soapy water or as directed by hospital policy (see section 5). Allow the pump to dry. 		
	Giving set not properly connected to the container.	<ul style="list-style-type: none"> Check position of giving set and insert correctly if necessary. ▶ see section 4.1.2. 		
Technical alarm	A technical alarm code is displayed with the "Pump error alarm" drawing.	<ul style="list-style-type: none"> Note the technical Error code (Err xyz). To release technical alarms, press  or  for 2 seconds. The pump will then switch off instantly (no count-down). Contact your biomedical department. 		
	The last battery technical alarm that occurred before switch OFF is reminded at the next switch ON.	<ul style="list-style-type: none"> Note the technical Error code (Err xyz). Contact your biomedical department. 		
Battery technical alarm		Fail safe technical alarm	Pump stops immediately.	<ul style="list-style-type: none"> Contact your biomedical department.
Start reminder		Pump is switched on but not operated for 2 minutes (2 beeps)	<ul style="list-style-type: none"> Proceed to next step or switch pump off. 	

7.1.3 Maximum alarm raising delay:

Time between alarm condition and alarm generation is less than 5 seconds, except for Giving set, Upstream and Downstream occlusions and Empty bag / Air in Line alarms (see section 8.1).



Information:

- *All alarms are MEDIUM PRIORITY (indicating that prompt OPERATOR response is required).*
- *When two alarms are raised at the same time, the pump software prioritizes the alarms.*

7.2 Troubleshooting

Issue description	Recommended action
Pump is not stable when mounted	<ul style="list-style-type: none"> ▪ Check that the clamp handle is fastened
Pump is damaged, noisy, smoking or with an abnormally hot part	<ul style="list-style-type: none"> ▪ Remove wall plug ▪ Do not use the device ▪ Contact your biomedical department or Fresenius Kabi After-Sales Service immediately
Pump has been dropped	<ul style="list-style-type: none"> ▪ Do not use the device ▪ Contact your biomedical department or Fresenius Kabi After-Sales Service
Pump does not start after switched ON	<ul style="list-style-type: none"> ▪ Connect pump to the mains supply in case the battery is fully discharged ▪ Contact your biomedical department or Fresenius Kabi After-Sales Service if problem remains
Flow rate variance is higher than flow rate accuracy	<ul style="list-style-type: none"> ▪ Check giving set configuration ▪ Check fluid viscosity ▪ Check the fluid is within normal temperature conditions ▪ Contact your biomedical department or Fresenius Kabi After-Sales Service if problem remains
Front panel problem (keys, LEDs)	<ul style="list-style-type: none"> ▪ Check the general state of the front panel ▪ Check the contrast ▪ Contact your biomedical department or Fresenius Kabi After-Sales Service if problem remains
The mains connection LED does not light up	<ul style="list-style-type: none"> ▪ Connect pump to the mains supply ▪ Contact your biomedical department or Fresenius Kabi After-Sales Service if problem remains
The device switches off on its own	<ul style="list-style-type: none"> ▪ Connect pump to the mains supply ▪ Contact your biomedical department or Fresenius Kabi After-Sales Service if problem remains
Battery alarm when pump has been correctly charged	<ul style="list-style-type: none"> ▪ Check mains supply voltage ▪ Contact your biomedical department or Fresenius Kabi After-Sales Service if problem remains
The device switches off when it is disconnected from the mains	<ul style="list-style-type: none"> ▪ Battery is completely discharged: Charge the battery ▪ Contact your biomedical department or Fresenius Kabi After-Sales Service if problem remains

8 Technical information

8.1 Performance

8.1.1 Essential performances

Pump essential performances are defined as follows in standard operating conditions:

- Flow rate accuracy ($\pm 7\%$ at 50 mL/h with medical water).
- Occlusion detection time (< 6 min at 50 mL/h with medical water).
- Bolus after occlusion release (< 5 mL with medical water).



Warning:

Flow rate accuracy can be influenced by giving set configuration, tube stretching, fluid viscosity, fluid temperature, container height and feeding settings.

8.1.2 Flow Rates range

Range: From 1 mL/h to 600 mL/h

Increments: 1 mL/h from 1 mL/h to 100 mL/h
5 mL/h from 100 mL/h to 600 mL/h

Accuracy: $\pm 7\%$ at 50 mL/h

Test initial conditions following 60601-2-24. Cumulative volume measured on a two-hours period, with 25 mL minimum volume. Container height: 50 cm.

8.1.3 Volume range

Range: From 1 mL to 5000 mL

Increments: 1 mL from 1 mL to 100 mL
5 mL from 100 mL to 5000 mL

8.1.4 Upstream and downstream occlusions

Occlusion alarm response time at different flow rates.

Occlusion detection time		
Flow rate	Downstream occlusion (2.2 m after the pump)	Upstream occlusion (5 cm before the pump)
1 mL/h	5 hours	30 min.
25 mL/h	9 min.	18 sec.
100 mL/h	2 min.	8 sec.

8.1.5 Empty bag / Air in Line alarm response time at different flow rates

Time mentioned is applicable only if the set has been previously filled.

Empty bag / Air in Line detection time	
Flow rate	Air volume = 3.5 mL
1 mL/h	3 hours 30 min. maximum
25 mL/h	10 min. maximum
100 mL/h	3 min. maximum

8.1.6 Giving set alarm response time at different flow rates

Flow rate	Giving set alarm detection time
1 mL/h	8 minutes maximum
25 mL/h	30 seconds maximum
100 mL/h	10 seconds maximum

8.2 Technical characteristics

8.2.1 Operation mode

The Amika pump is a reusable device. The pump ensures a fluid delivery in a continuous feeding mode, using pumping and clamping fingers for advancing the liquid to the patient.

8.2.2 Power supply specifications

The wall plug must be connected directly to the mains power socket.

Wall plug input: AC input voltage: 100-240 Vac \pm 10%
AC input frequency: 50-60 Hz
AC input current: 205 mA

Wall plug output: 9 Vdc \pm 5 % / 1.0 A

Wall plug cord length: Approximately 2.5 m

8.2.3 Battery specifications

Characteristics: NiMH (Nickel-Metal Hydride)
4.8V 1.8Ah

Weight: Approximately 100 g

Pump battery mode: 24 h \pm 5% at 125 mL/h
(in standard feeding conditions,
at 22.5°C \pm 2.5°C)

Maximum charging time: 6 hours

8.2.4 Power consumption

Consumption of the pump in standard operating conditions:
Maximum 7 W.

8.2.5 Dimensions - Weight

	Weight	Dimensions (H x W x D)
Pump	610 g	138 x 128 x 48 mm
Holder	350 g	185 x 110 x 85 mm
Wall plug	200 g	-
Packaging	500 g	-

8.2.6 Trumpet curves

The trumpet curve shows the variations of the mean flow accuracy over specific observation periods. The variations are presented only as maximum and minimum deviations from the overall mean flow within the observation window.

The test protocol used to obtain these results is described in EN/IEC 60601-2-24.

The curves can be helpful in determining the suitability of feeding parameters for specific nutritions.

Giving set used: Amika - Pump Set VarioLine

Fluid used: Distilled water

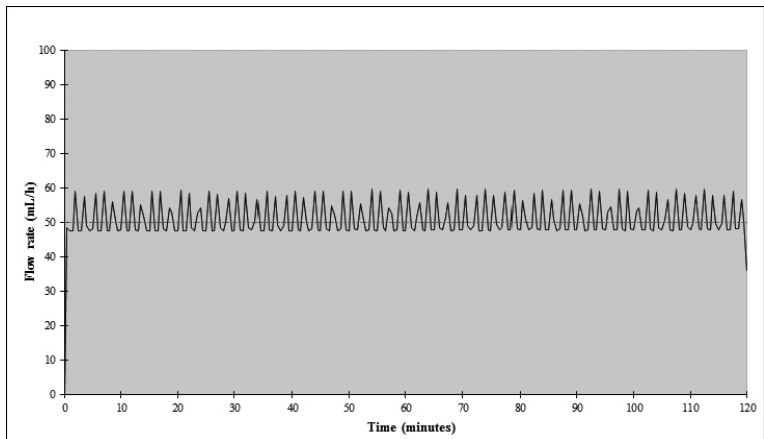

Instantaneous rate at 50 mL/h over 2 hours:

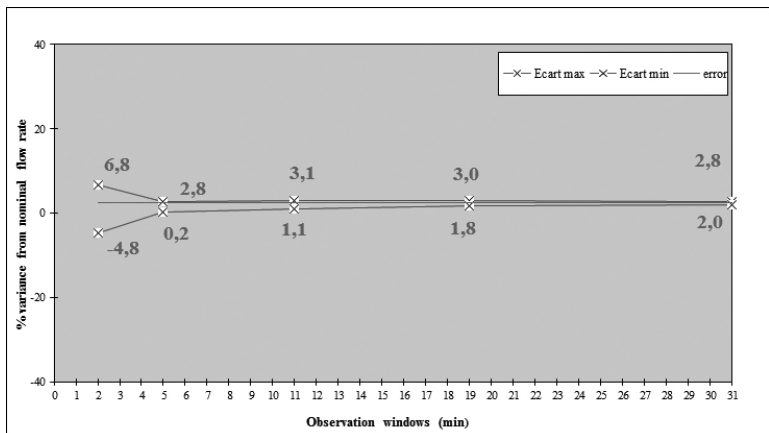

Trumpet curve on 2nd hour:



8.2.7 Compliance with standards

	Conform to the 93/42/EEC Medical directive	Protection against moisture: Pump: IP34 (splash-protected) Holder: IP32 (drip-protected)
Safety of ElectroMedical Equipments	Conform to EN/IEC 60 601-1: 2006	Wall plug: IP41 (drip-protected)  Protection against leakage current: Defibrillation-proof type CF applied part.
EMC (ElectroMagnetic Compatibility)	Conform to EN/IEC 60 601-1-2: 2007	 Protection against electric shocks: class II.



Warning:

The device is protected against leakage current and do not disturb ECG or EEG devices.

9 Transport, storage and recycling conditions

9.1 Storage and transport conditions



Warning:

- *The Amika pump shall not be removed from its pole or rail when carrying feeding devices, especially when feeding is running.*
- *Check wall plug is connected and operational after transport of the pump.*
- *The pump should be used under the specified storage and transport conditions listed below to ensure pump performance.*
- *Storage and transport temperature: -20°C to +45°C.*
- *Storage and transport pressure: 500 hPa to 1060 hPa.*
- *Storage and transport humidity: 10% to 90%, no condensation.*

9.2 Storage

DANGER

Danger!

Please make sure the pump is stored in an appropriate manner so as to avoid pump malfunctioning.



Information:

- *The storing area must be clean, organized and compliant with the storing conditions mentioned above.*
- *The Amika pump must be handled with care during storage.*

Caution:



- *If the device is not used for longer than 2 months, remove the battery and store it as per storage conditions above.*
- *If the device is stored without removing the battery, charge it at least once a month by connecting it to the mains for at least 6 hours.*
- *Amika must be cleaned and disinfected prior to storage (see section 5).*

9.2.1 Prepare the device for storage

In order to prepare the device before storage, proceed as follows:

1. Be sure the pump is not being used on a patient
2. Switch pump OFF and remove installed giving set (see section 4.2.8).
3. Disconnect pump power cord (see section 3.2.3).
4. Remove the pump and its holder from pole or rails (see section 3.2.1).
5. Clean the pump (see section 5).
6. Handle the pump with care and store it in a compliant area.

9.2.2 Install the device after storage

Information:

- *If the battery has been removed for storage, please contact your biomedical department in order to replace the battery into the device prior to using the pump.*
- *We recommend charging the battery, by leaving the device connected to the mains power supply for at least 6 hours. After prolonged storage, a few minutes may be required before using the pump (an hourglass will be displayed).*
- *We recommend that the "Amika Quick check protocol" is performed when the device is installed after transport, in case of a prolonged storage, or before being used on new patient.*



9.3 Recycling and disposal

Danger!

Before disposal, remove battery from the device. Batteries and devices with this label must not be disposed of with the general waste. They must be collected separately and disposed of according to local regulations.



DANGER

For further information regarding waste processing regulations, contact your local Fresenius Kabi organisation or the local distributor.

10 Guidance and manufacturer's declaration on EMC

The Amika pump is intended to be used in the electromagnetic environment specified below.

The customer or the user of the Amika pump should assure that it is used in such an environment.

Excluding the cases described in this manual, the pump operation must systematically be checked by a qualified operator, should the pump be installed in the vicinity of other electrical devices.

10.1 Electromagnetic compatibility and interference guidance

The Amika has been tested in accordance with the electromagnetic compatibility standards applicable to medical devices. Its immunity is designed to ensure correct operation. Limitation of the emitted radiation avoids undesirable interference with other equipment.

The Amika is classified as a Class B device according to CISPR 11 emitted radiation. The user might be required to take mitigation measures, such as relocating or re-orienting the equipment.

Use of accessories and cables other than those recommended by Fresenius Kabi, could result in increased emissions and / or decreased immunity of the Amika system.

If the Amika is placed near devices such as HF surgical equipment, X-ray equipment, NMR, cell phones, DECT phones or wireless access points, portable RFID reader, large scale RFID reader and RFID Tags, it is essential to observe a minimum distance between the Amika and this equipment (see *section 10.3*). If the Amika causes harmful interference or if it is itself disrupted, the user is encouraged to try to correct the interference by one of the following actions:

- Reorient or relocate the Amika or patient or disruptive equipment.
- Change the routing of cables.
- Connect the Amika mains plug on protected / backed-up / filtered supply or directly on UPS circuit (uninterruptible power supply).
- Increase the separation between the Amika and patient or disruptive equipment.
- Connect the Amika into an outlet on a circuit different from that to which the patient or disruptive equipment is connected.
- In any case, whatever the context, the user should conduct interoperability testing in a real situation to find the right setup and good location.

10.2 Table 4 - Guidance and manufacturer's declaration - Electromagnetic immunity

The Amika pump is intended to be used in the electromagnetic environment specified below.

The customer or the user of the Amika pump should assure that it is used in such an environment.

10.3 Table 6 - Recommended separation distances between portable and mobile RF communication equipment and pump

The Amika pump is intended to be used in an electromagnetic environment in which radiated RF disturbances are controlled.

Users of the Amika may prevent electromagnetic interference by maintaining a minimum distance between portable and mobile RF communications equipment (transmitters) and the Amika as recommended below and according to the maximum output power of the communication equipment (transmitters).

The Amika should not be used next to other equipment. If adjacent use is necessary, the device should be observed to verify normal operation in the configuration in which it will be used (pump with a AC Power cable).

Wireless communication devices such as home devices in wireless network, mobile phones, cordless phones and their bases, walkie-talkies can affect the Amika. It is recommended to keep those devices at a distance greater than 3.3 meters from the Amika.

For transmitters rated at a maximum output power not listed above, the recommended separation distance d in metres (m) can be estimated using the equation applicable to the transmitter frequency, where P is the maximum output power rating of the transmitter in watts (W) according to the transmitter manufacturer.

Warning:

- *At 80 MHz and 800 MHz, the separation distance for the higher frequency range applies.*
- *These guidelines may not apply in all situations. Electromagnetic propagation is affected by absorption and reflection from structures, objects and people.*
- *The device should not be used next to other equipment. If adjacent use is necessary, the device should be observed to verify normal operation in the configuration in which it will be used (pump with a mains cable).*



11 Services

11.1 Warranty

11.1.1 General conditions of warranty

Fresenius Kabi guarantees that this product is free from defects in material and workmanship during the period defined by the accepted sales conditions, except for the batteries and the accessories.

11.1.2 Limited warranty

To benefit from the materials and workmanship guarantee from our After-Sales Service or agent authorized by Fresenius Kabi, the following conditions must be respected:

- Fresenius Kabi is not liable for loss or damage to the device during transport.
- The device must have been used according to the instructions described in this user guide and other accompanying documents.
- The device must not have been damaged when in storage, at the time of repair, or show signs of improper handling.
- The device must not have been altered or repaired by non-qualified personnel.
- The internal battery of the device must not have been replaced by a battery other than that specified by the manufacturer.
- The serial number (ID/N°) must not have been altered, changed, or erased.

Information:



- *In case of non-respect of these conditions, Fresenius Kabi will prepare an estimate for repair covering the parts and labour required.*
- *When a return and/or a repair of the device are required, please contact your Fresenius Kabi After-Sales Service.*

11.1.3 Warranty conditions for battery and accessories

Batteries and accessories may have specific conditions of warranty. Please contact your Fresenius Kabi sales representative for additional information.

11.2 Quality control

Upon request by the hospital, a **quality control** check can be performed on the Amika **every 12 months**.

A regular quality control (not included in the guarantee) consists of various inspection operations listed in the technical manual. Please refer to the technical manual or contact your Fresenius Kabi After-Sales Service.



Information:

- *These control checks must be performed by a trained technical personnel and are not covered by any contract or agreement provided by Fresenius Kabi.*
- *For more information, please contact our After-Sales Service department.*

11.3 Maintenance requirements

Warning:



- *To ensure the device continues to operate normally, it is recommended that preventive maintenance of the device is performed **every two years**. This includes battery and membrane replacement.*
- *To avoid pumping performances deterioration, it is important to follow maintenance requirements.*
- *Preventive maintenance must be performed by a qualified and trained technical personnel in compliance with the technical manual and procedures.*
- *The qualified personnel must be informed if the device is dropped or if any malfunction occurs. In this case, the device must not be used. Please contact your biomedical department or Fresenius Kabi.*
- *When replacing components, only use Fresenius Kabi spare parts.*

Life cycle of Amika pump: 10 years provided that the maintenance is properly performed as described above.

11.4 Service policy and rules

For further information concerning the device servicing or use, please contact our After-Sales Service or our Customer service.

DANGER

Danger!

If the device must be sent for servicing, contact Fresenius Kabi to have packaging shipped to your facility. Clean and disinfect the device, because of potential harm or risks to staff health. Then pack it in the provided packaging and ship to Fresenius Kabi.



Information:

Fresenius Kabi is not liable for loss or damage to the device during transport.

12 Ordering information

12.1 Wall plug

Each Product reference includes its own appropriate wall plug, depending on the country. Please contact your Fresenius Kabi sales representative for ordering.

12.2 Instructions for use



Warning:

Several 'Instructions for use' documents translated into local languages are available. Please contact your Fresenius Kabi sales representative for ordering.

12.3 Giving sets



Warning:

Do not use Amika giving sets to deliver liquids using gravity method, except the Amika set Varioline Comfort that can be used either for feeding by pump or by gravity.

Giving sets	Reference
Amika Set EasyBag	7751729
Amika Set EasyBag, ENLock	7751733
Amika Set EasyBag, ENPlus	7751826
Amika Set EasyBag, ENLock, ENPlus	7751805
Amika Y-Set EasyBag	7751832
Amika Y-Set EasyBag, ENPlus	7751827
Amika Set EasyBag Mobile	7751810
Amika Set EasyBag Mobile, ENLock	7751784
Amika Set EasyBag Mobile, ENPlus	7751828
Amika Set EasyBag Mobile, ENLock, ENPlus	7751806
Amika Set Varioline	7751690
Amika Set Varioline, ENLock	7751697
Amika Set Varioline, ENPlus	7751829
Amika Set Varioline, ENLock, ENPlus	7751808

Giving sets	Reference
Amika Set Varioline Comfort	7751830
Amika Set Varioline Comfort, ENLock, ENPlus	7751825
Amika Set Bag	7751743
Amika Set Bag, ENLock	7751809
Amika Set Bag Mobile	7751745
Amika Set Bag Mobile, ENLock	7751738

12.4 Accessories

Danger!

DANGER

Use ONLY recommended accessories delivered with the device or described below. Please refer to its specific instructions for use.

Accessories	Reference
Amika Backpack Large	7752323
Amika Backpack Small	7752343
Universal Table Top Stand	7751082
Amika Holder COM Nurse Call	Z044901

13 Glossary of terms

Term	Description
°C	Celsius Degree
A	Amper
AC	Alternating Current
Ah	Amper hours
Amika	Enteral feeding and hydration pump manufactured by Fresenius Kabi
CE mark	European Conformity Mark
CISPR	Special International Committee on Radio Interference
cm	Centimeters
dB	Decibel
DECT	Digital Enhanced Cordless Telecommunications
ECG	Electrocardiogram
EEG	Electroencephalogram
EMC	Electromagnetic compatibility
EXX	Error message
g	Gram
h	Hours
H x W x D	Height / Width / Depth
HF	High Frequency
hPa	Hecto Pascal
Hz	Hertz
ID/N°	Serial number
IEC	International Electrotechnical Commission
IFU	Instructions For Use
IV	Intravenous
LED	Light Emitting Diode
m	Meters

Term	Description
MHz	MegaHertz
min	Minutes
mL	Milliliter
mL/h	Milliliter per hour
mm	Millimeters
MRI	Magnetic Resonance Imaging
NiMH	Nickel-Metal Hydride
NMR	Nuclear Magnetic Resonance
RF	Radio Frequency
RFID	Radio Frequency Identification
sec	Seconds
UPS	Uninterruptable Power Supply
V	Volt
Vac	Volt Alternating Current
Vdc	Volt Ampere
W	Watt

This IFU may contain inaccuracies or typographical errors.

Modifications may thus be made and will be included in later editions.

Because of the evolution of the standards, lawful texts and material, the characteristics indicated by the text and the images of this document are applicable only for the device that it accompanies.

This IFU may not be reproduced in whole or in part without the written consent of Fresenius Kabi.

The software may not be copied except for archival purposes or for backup, or replacement of defective media.

Amika® is a registered trademark in the name of Fresenius Kabi in selected countries.

Revision date: April 2014



Fresenius Kabi AG
61346 Bad Homburg
Germany
www.fresenius-kabi.com





210304-0



**FRESENIUS
KABI**

caring for life